

DIN-MS-4P Four-way mic splitter (1x4)

- **Balanced mic splitter sends signal to four outputs**
- **Eliminates hum and buzz caused by ground loops**
- **Linear frequency response from 5 Hz to 50 kHz**
- **Easy to use DIN rail format for quick installations**



The Iso•Max DIN-MS-4P is a passive single channel mic splitter that lets you take a microphone signal and send it to four mixing consoles at the same time.

The design begins with a gray molded assembly made from UL94-VO flame retardant Noryl that snaps into place onto a standard 35 mm DIN rail for easy installation in a NEMA enclosure. Connections to and from the module are made via removable screw-down wire terminals. Plug and play easy to use, this passive interface does not require any power to work. Inside is a premium Jensen mic bridging transformer equipped with four internal faraday shields and an external mu-metal can. This isolates the mic inputs, eliminating ground loops while reducing common-mode noise by as much as 130 dB.

Made for the most demanding professionals, the DIN-MS-4P delivers a ruler flat response from 5 Hz to 50 kHz with less than 2° phase shift at all frequencies with minimal insertion loss. This makes the DIN-MS-4P ideal for isolating and distributing mic signals in performance venues, broadcast houses and broad scale AV installations.

Applications

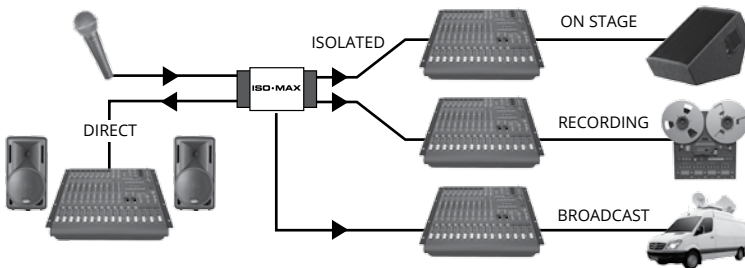

DIN-MS-4P Splitting a mic signal

The Jensen DIN-MS-4P is the perfect interface for splitting a microphone to feed more than one mixer at the same time. 100% isolation eliminates potential ground loops between the two consoles for quiet performance. The main thru-put provides a 48V phantom power return path for condenser mics or active direct boxes.

Dimensions

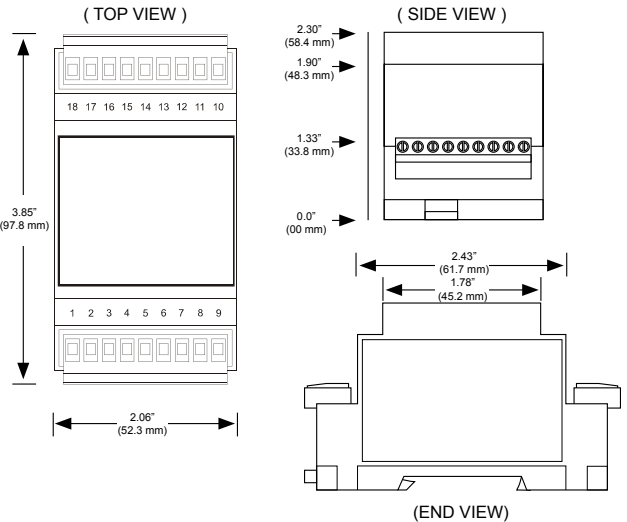

Module Schematic Diagram

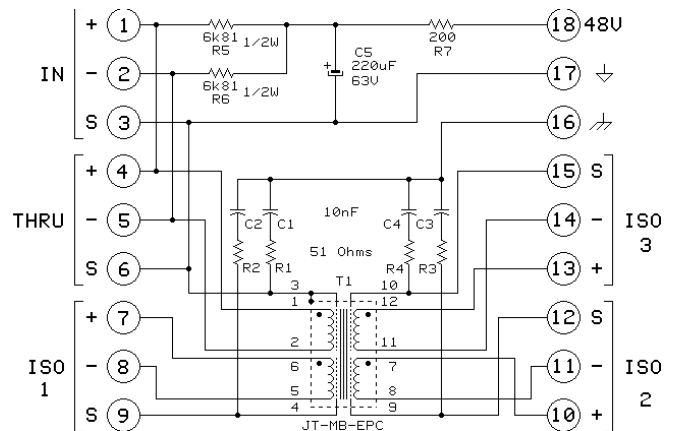

Onboard provisions allow local 48V phantom power to the connectors

Understanding ground loops

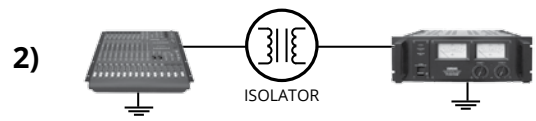
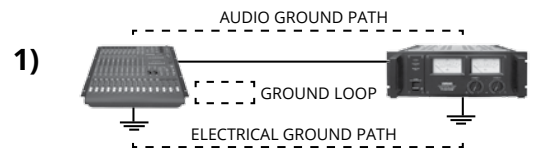

Lifting the ground and passing the signal through the transformer totally eliminates the ground loop

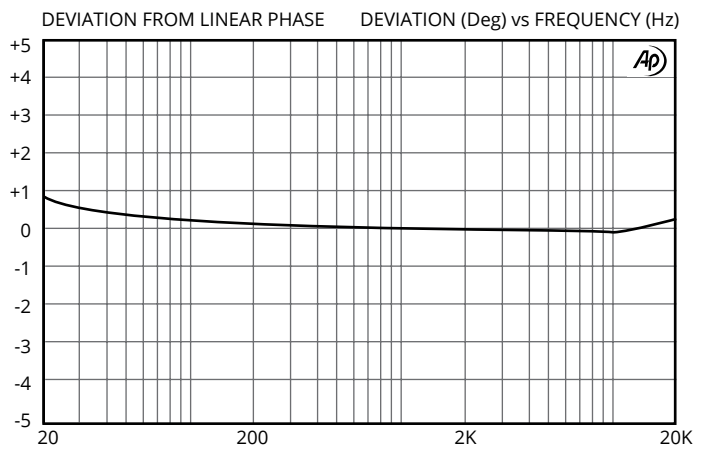
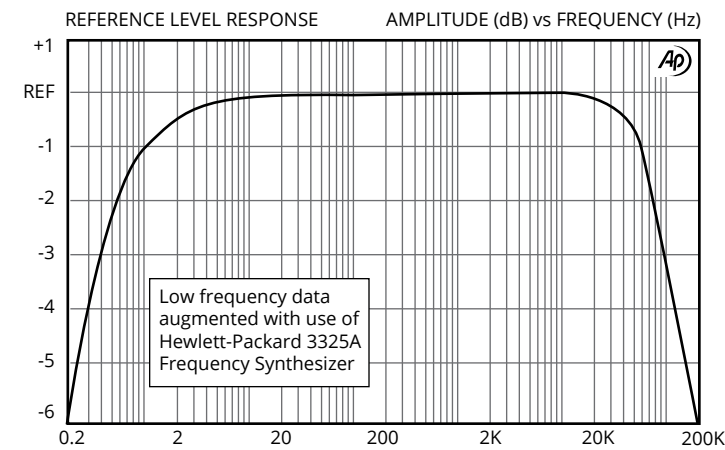
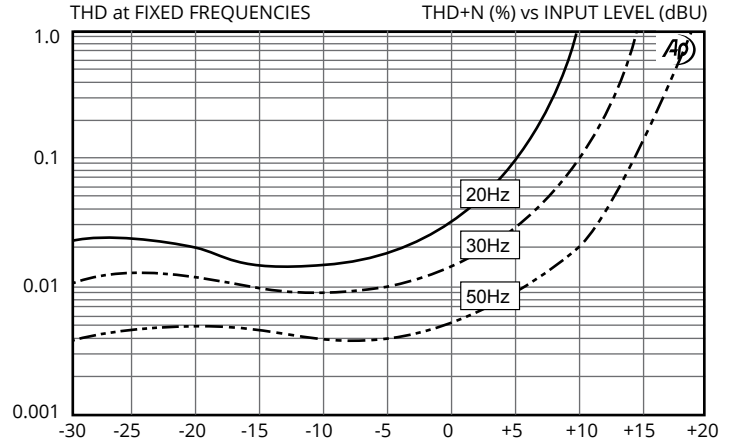
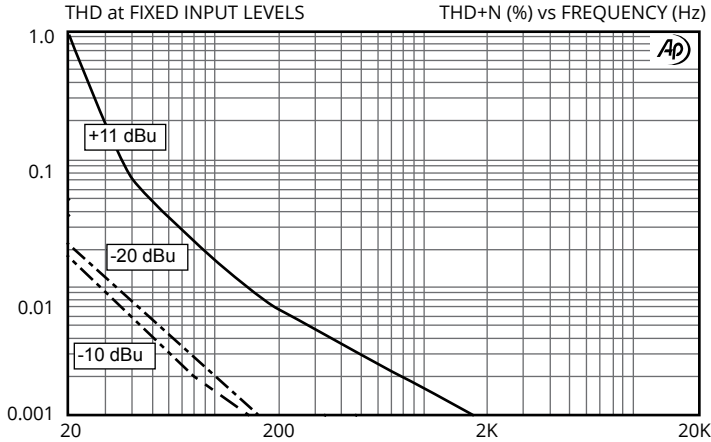

PARAMETER	CONDITIONS	MINIMUM	TYPICAL	MAXIMUM
Input impedance, Zi	1 kHz, -20 dBu, test circuit 1	980 Ω	1.0 kΩ	1.02 kΩ
Voltage gain	1 kHz, -20 dBu, test circuit 1	-2.5 dB	-2.2 dB	-2.0 dB
Magnitude response, ref 1 kHz	20 Hz, -20 dBu, test circuit 1	-0.1 dB	-0.05 dB	±0.0 dB
	20 kHz, -20 dBu, test circuit 1	-0.5 dB	-0.27 dB	-0.1 dB
Deviation from linear phase (DLP)	20 Hz to 20 kHz, -20 dBu, test circuit 1		+0.9/-0°	±2.0°
Distortion (THD)	1 kHz, -20 dBu, test circuit 1		<0.001%	
	20 Hz, -20 dBu, test circuit 1		0.022%	0.08%
Maximum 20 Hz input level	1% THD, test circuit 1	+9 dBu	+11 dBu	
Common - mode rejection ratio (CMRR) 150 Ω balanced source	60 Hz, test circuit 2		120 dB	
	3 kHz, test circuit 2		75 dB	
Output impedance, Zo	1 kHz, test circuit 1		285 Ω	
Optimal cable length	input		8 m (26')	30 m (100')
	output		30 m (100')	100 m (300')
Temperature range	operation or storage		0°C	70°C
Breakdown voltage*	primary or secondary to shields, 60 Hz		250 V RMS	

All levels are output unless noted

Test Circuit 1:

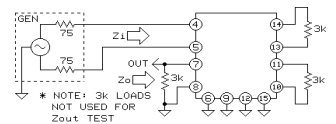

Test Circuit 2:

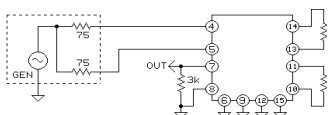

* IMPORTANT NOTE: THIS PRODUCT IS NOT INTENDED FOR USE IN CIRCUMSTANCES WHERE THE DC OR PEAK AC VOLTAGE BETWEEN INPUT AND OUTPUT CONNECTIONS EXCEEDS 34 VOLTS OR WHERE ITS FAILURE COULD CAUSE INJURY OR DEATH.

All minimum and maximum specifications are guaranteed. Unless noted otherwise, all specifications apply at 25°C. Specifications subject to change without notice. All information herein is believed to be accurate and reliable, however no responsibility is assumed for its use nor for any infringements of patents which may result from its use. No license is granted by implication or otherwise under any patent or patent rights of Jensen Transformers, Inc.