

Line Input Transformer
1:1 SPLIT WINDING 'REPEAT COIL'

- Ideal for use with low input impedance circuits
- Wide bandwidth: -3 dB at 0.4 Hz and 200 kHz
- Recommended for levels up to +21 dBu at 20 Hz
- Insertion loss only 1.9 dB in 600 Ω to 600 Ω application
- High common-mode rejection: 125 dB at 60 Hz

This transformer has split primary and secondary windings which can be connected for either 1:2 (150:600 Ω), 1:1 (600:600 Ω), or 2:1 (600:150 Ω) operation. Distortion, although specified for 600 Ω sources, will be further reduced by lower impedances.

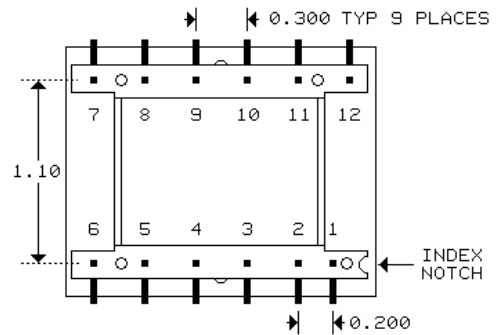
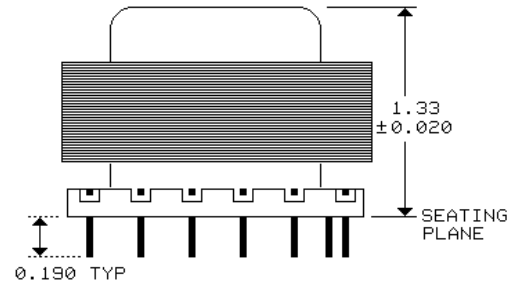
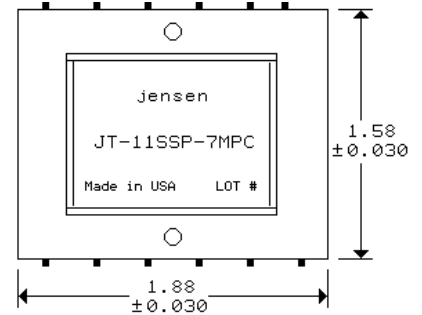

PIN NUMBERS NOT MARKED ON PART
PINS ARE 0.025 SQUARE, 12 PLACES
0.040 DIA PC HOLES RECOMMENDED

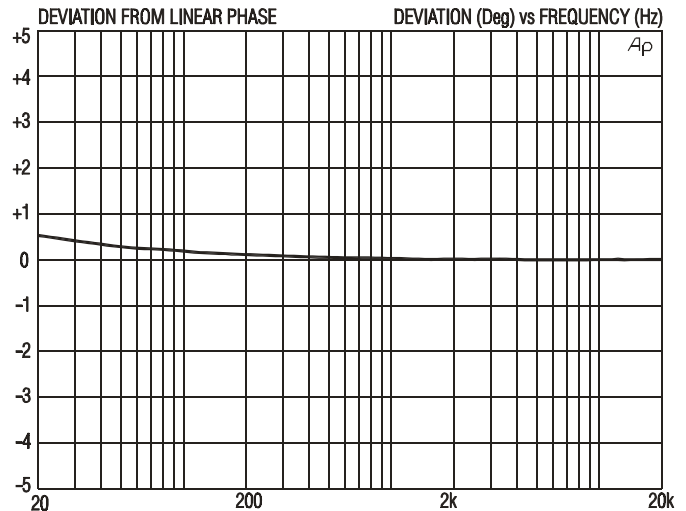
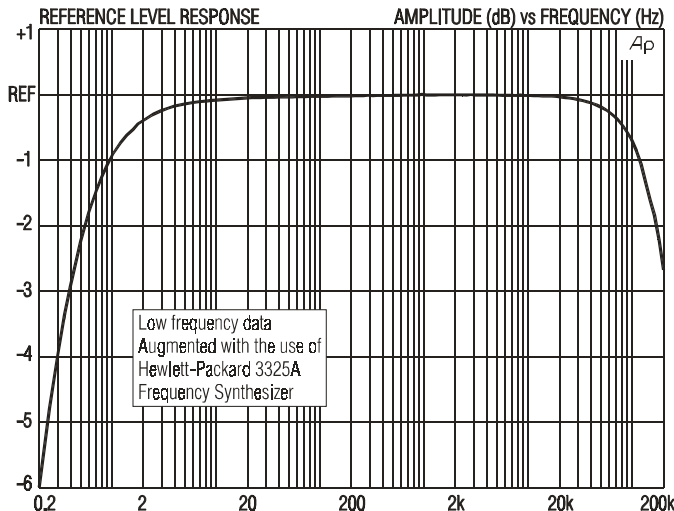
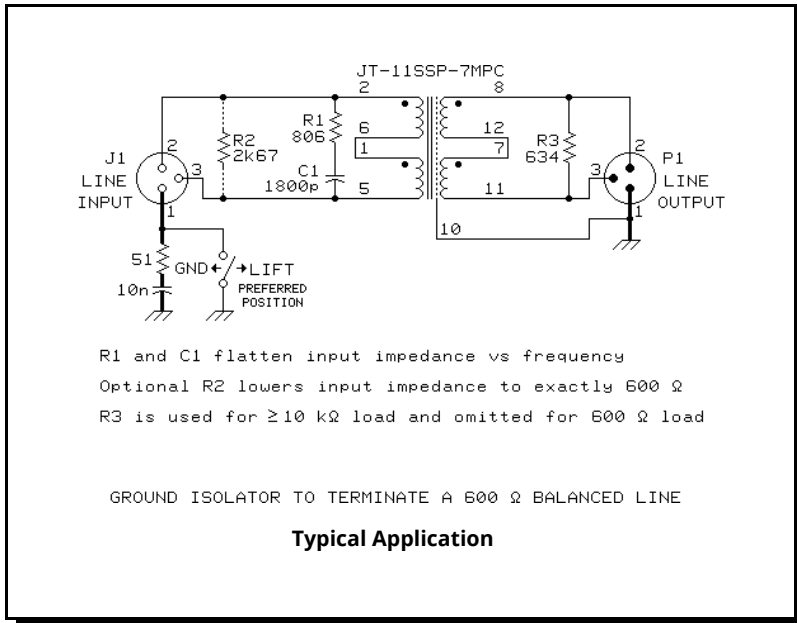

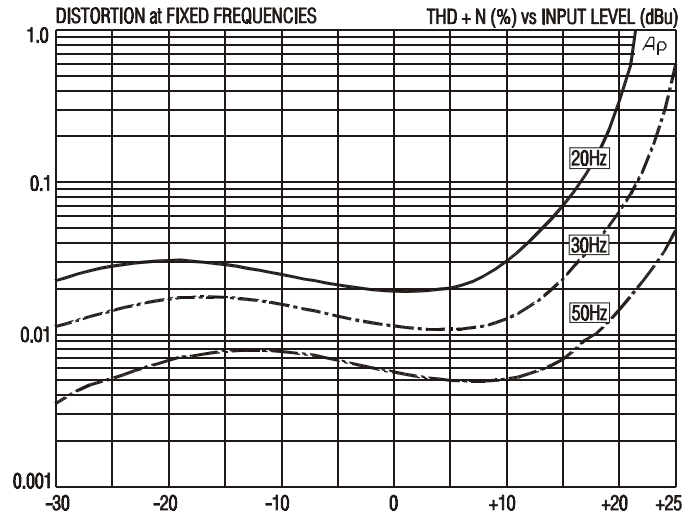
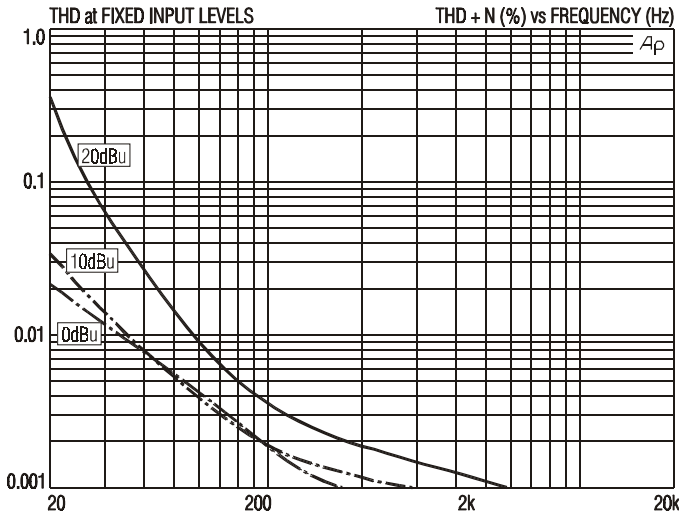

JT-11SSP-7MPC SPECIFICATIONS (1:1 series/series configuration, all levels are input unless noted)

PARAMETER	CONDITIONS	MINIMUM	TYPICAL	MAXIMUM
Input impedance, Zi	1 kHz, +4 dBu, test circuit 1	743 Ω	750 Ω	757 Ω
Voltage gain	1 kHz, +4 dBu, test circuit 1	-2.1 dB	-1.9 dB	-1.7 dB
Magnitude response, ref 1 kHz	20 Hz, +4 dBu, test circuit 1, Rs=600 Ω	-0.2 dB	-0.06 dB	±0.0 dB
	20 kHz, +4 dBu, test circuit 1, Rs=600 Ω	-0.1 dB	-0.02 dB	+0.1 dB
Deviation from linear phase (DLP)	20 Hz to 20 kHz, +4 dBu, test circuit 1, Rs=600 Ω		+0.6/-0°	±2.0°
Distortion (THD)	1 kHz, +4 dBu, test circuit 1, Rs=600 Ω		<0.001%	
	20 Hz, +4 dBu, test circuit 1, Rs=600 Ω		0.025%	0.10%
Maximum 20 Hz input level	1% THD, test circuit 1, Rs=600 Ω	+19 dBu	+21 dBu	
Input Common-mode rejection (CMRR) 600 Ω balanced source	60 Hz, test circuit 2		125 dB	
	3 kHz, test circuit 2	75 dB	95 dB	
Output Common-mode rejection (CMRR) 600 Ω balanced load	60 Hz, test circuit 3		110 dB	
	3 kHz, test circuit 3		80 dB	
Output impedance, Zo	1 kHz, test circuit 1, Rs=600 Ω		750 Ω	
DC resistances	total primary, Pin 2 to Pin 5, Pin 1 and Pin 6 shorted		39 Ω	
	total secondary, Pin 8 to Pin 11, Pin 7 and Pin 12 shorted		112 Ω	
Capacitances @ 1 kHz	total primary to shield and case		676 pF	
	total secondary to shield and case		531 pF	
Turns ratio	any winding to any other winding	0.999:1	1.000:1	1.001:1
Temperature range	operation or storage	0° C		70° C
Breakdown voltage (see IMPORTANT NOTE below)	primary or secondary to shield and case, 60 Hz, 1 minute test duration	250 V RMS		

IMPORTANT NOTE: This device is NOT intended for use in life support systems or any application where its failure could cause injury or death. The breakdown voltage specification is intended to insure integrity of internal insulation systems; continuous operation at these voltages is NOT recommended. Consult our applications engineering department if you have special requirements.

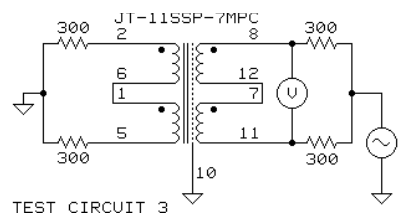
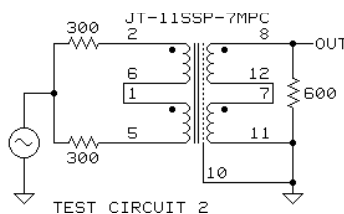
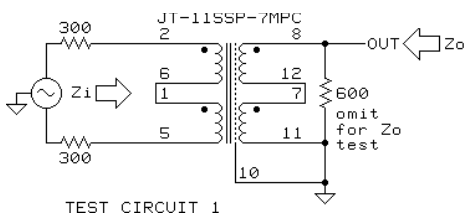

All minimum and maximum specifications are guaranteed. Unless noted otherwise, all specifications apply at 25°C. Specifications subject to change without notice. All information herein is believed to be accurate and reliable, however no responsibility is assumed for its use nor for any infringements of patents which may result from its use. No license is granted by implication or otherwise under any patent or patent rights of Jensen Transformers, Inc.