

**Microphone Input Transformer**  
DOUBLE SHIELDED VERSION OF JT-115K-E

- Ideal for FET or vacuum tube input amplifiers
- Wide bandwidth: -3 dB at 2.5 Hz and 90 kHz
- 20 dB of voltage gain with Noise Figure of only 1.5 dB
- Input impedance of 1.4 kΩ for loading loss of 0.9 dB
- High common-mode rejection: 110 dB at 60 Hz

This transformer is packaged in double nested cans which provide 60 dB of magnetic shielding to prevent hum pickup in 'hostile' environments. The white lead connects to the inner can and the white-black to the outer can. Although physically larger, it is electrically identical to our standard JT-115K-E.

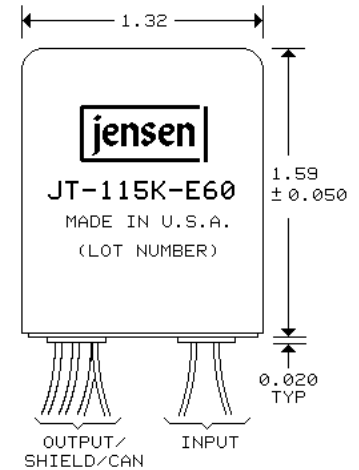

#30 AWG (7×38) UL STYLE 1061 COLOR CODED WIRE LEADS, 8" MINIMUM LENGTH

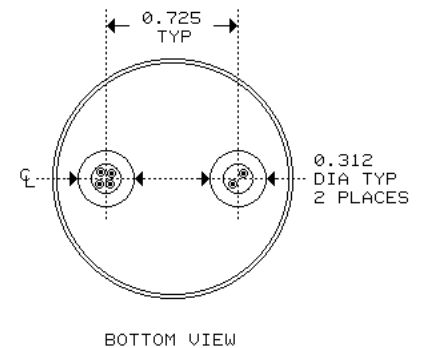

RECOMMENDED MOUNTING IS WITH UR-3 CLAMP  
(SUPPLIED WITH TRANSFORMER)

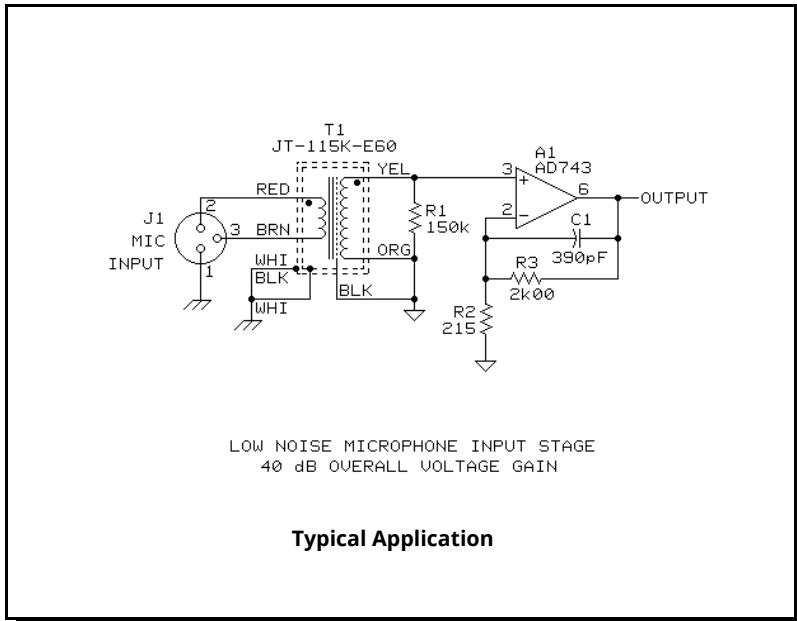

**Typical Application**

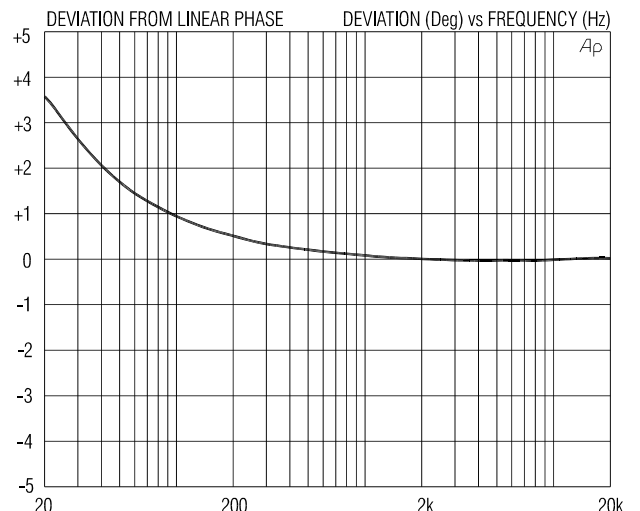
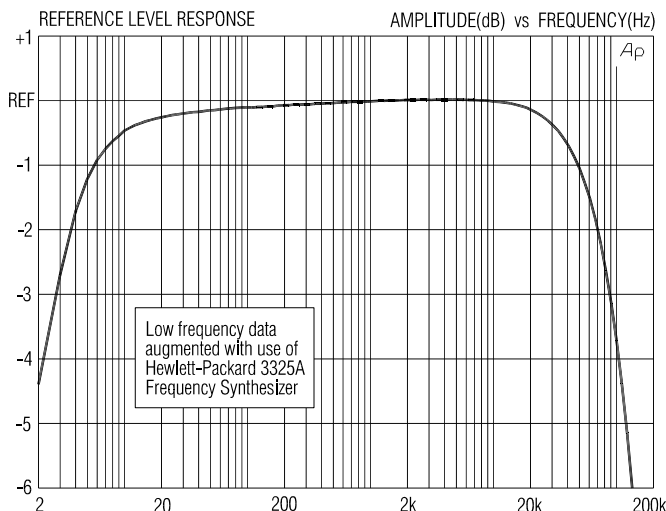

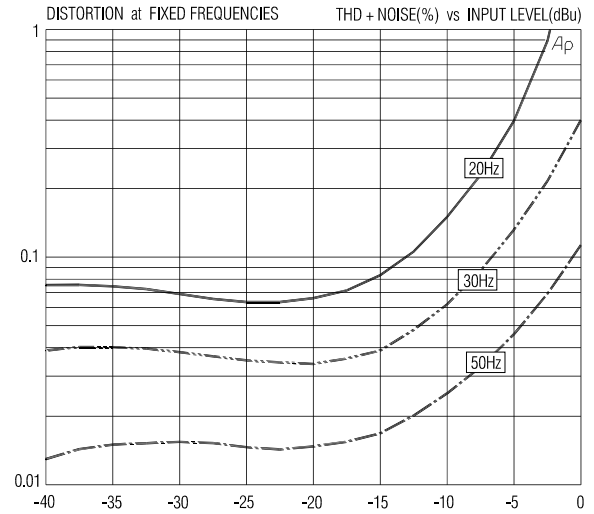
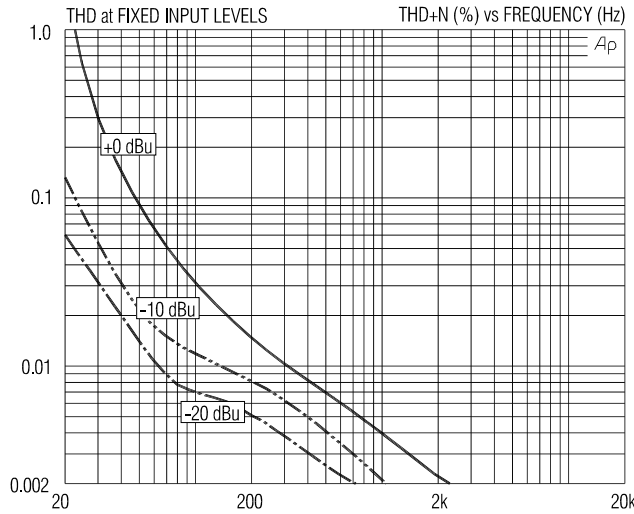

**JT-115K-E60 SPECIFICATIONS** (all levels are input unless noted)

PARAMETER	CONDITIONS	MINIMUM	TYPICAL	MAXIMUM
Input impedance, Zi	1 kHz, -20 dBu, test circuit 1	1.33 kΩ	1.40 kΩ	1.47 kΩ
Voltage gain	1 kHz, -20 dBu, test circuit 1	19.65 dB	19.75 dB	19.85 dB
Magnitude response, ref 1 kHz	20 Hz, -20 dBu, test circuit 1	-0.50 dB	-0.26 dB	±0.0 dB
	20 kHz, -20 dBu, test circuit 1	-0.25 dB	-0.13 dB	+0.1 dB
Deviation from linear phase (DLP)	20 Hz to 20 kHz, -20 dBu, test circuit 1		+3.5/-0°	±5.0°
Distortion (THD)	1 kHz, -20 dBu, test circuit 1		0.001%	
	20 Hz, -20 dBu, test circuit 1		0.065%	0.15%
Maximum 20 Hz input level	1% THD, test circuit 1	-4 dBu	-2.5 dBu	
Common-mode rejection ratio (CMRR) 150 Ω balanced source	60 Hz, test circuit 2		110 dB	
	3 kHz, test circuit 2	70 dB	78 dB	
Output impedance, Zo	1 kHz, test circuit 1		17.0 kΩ	
DC resistances	primary (RED to BRN)		19.7 Ω	
	secondary (YEL to ORG)		2465 Ω	
Capacitances @ 1 kHz	primary to shield and case		475 pF	
	secondary to shield and case		205 pF	
Turns ratio		1:9.95	1:10.00	1:10.05
Temperature range	operation or storage	0° C		70° C
Breakdown voltage (see IMPORTANT NOTE below)	primary or secondary to shield and case, 60 Hz, 1 minute test duration	250 V RMS		

**IMPORTANT NOTE:** This device is NOT intended for use in life support systems or any application where its failure could cause injury or death. The breakdown voltage specification is intended to insure integrity of internal insulation systems; continuous operation at these voltages is NOT recommended. Consult our applications engineering department if you have special requirements.

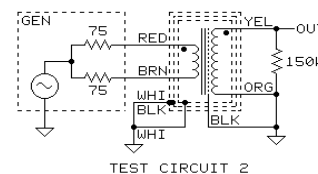
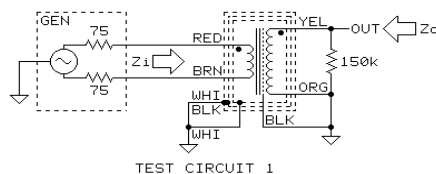

All minimum and maximum specifications are guaranteed. Unless noted otherwise, all specifications apply at 25°C. Specifications subject to change without notice. All information herein is believed to be accurate and reliable, however no responsibility is assumed for its use nor for any infringements of patents which may result from its use. No license is granted by implication or otherwise under any patent or patent rights of Jensen Transformers, Inc.