

Formerly DIN-2LO-11FL

DIN-2LOF Line output isolator

- Drives balanced and unbalanced signals long distances
- Eliminates hum and buzz caused by ground loops
- Withstands input levels in excess of +21 dB at 20 Hz
- Easy to use DIN rail format for quick installations



The Iso•Max DIN-2LOF is a two channel output isolator for both balanced and unbalanced signals where extreme signal handling is required to drive long cable runs.

The design begins with a gray molded assembly made from UL94-VO flame retardant Noryl that snaps into place onto a standard 35 mm DIN rail for easy installation in a NEMA enclosure. Connections to and from the module are made via removable screw-down wire terminals. Plug and play easy to use, this passive interface does not require any power to work. Inside are two high performance nickel core Jensen transformers that are able to withstand signals in excess of +21 dBu without discernible distortion while delivering a linear response to 10 Hz to 50 kHz. This provides galvanic isolation between the input and output to eliminate hum and buzz caused by ground loops, rejecting noise by as much as 94 dB. To further optimize the performance, a choice of connection point options enable the user to determine the most appropriate grounding scheme to suit the installation.

These features make the Iso•Max DIN-2LOF a superb choice for the most demanding broadcast, AV and performance venue installations.

Applications

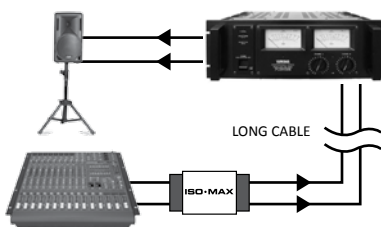

DIN-2LOF with a PA system

Eliminating noise in a PA system can sometimes take hours of trouble shooting, particularly when the mixer, amplifiers and speakers are distanced apart. Simply connect the DIN-2LOF at the output of your mixer to instantly eliminate ground loop hum and buzz.

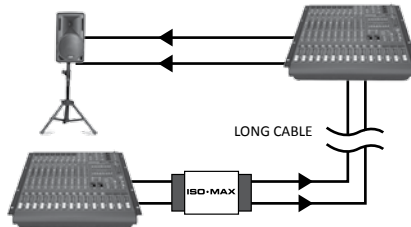

Isolating two consoles

Whether you are isolating two consoles in a festival or experiencing noise when connecting to a drive rack, the DIN-2LOF is easily inserted into the signal chain to break the ground loop and eliminate noise as it easily handles huge bass transients without distortion.

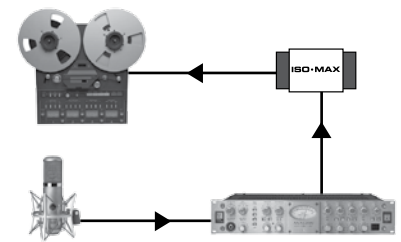

DIN-2LOF in the studio

Recording and broadcast studios require a noise-free signal transfer while delivering the most accurate sound possible. The Iso•Max DIN-2LOF eliminates ground loops without introducing distortion, phase shift or artifact.

Dimensions

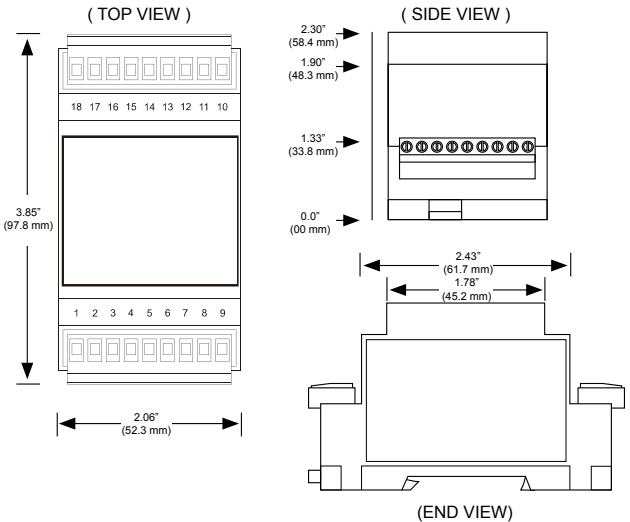

Module Schematic Diagram

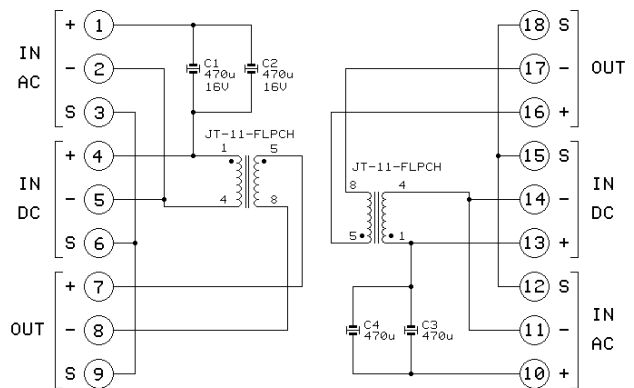

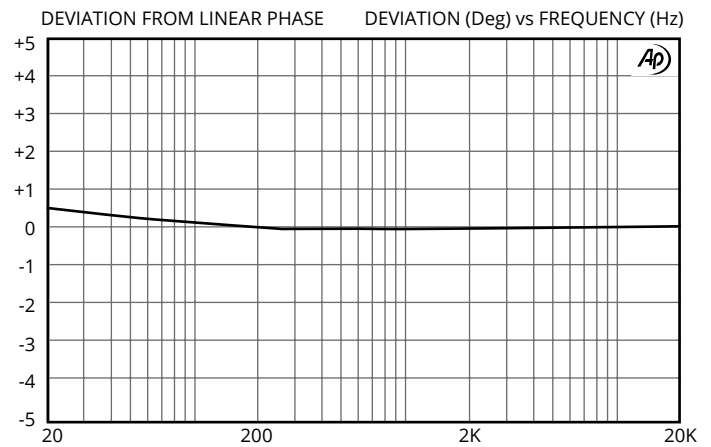
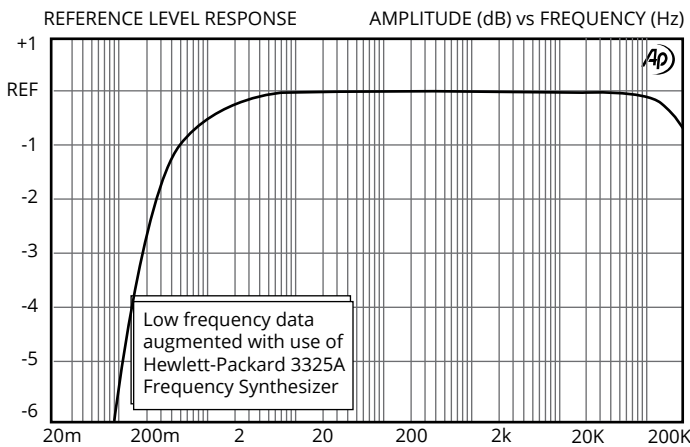
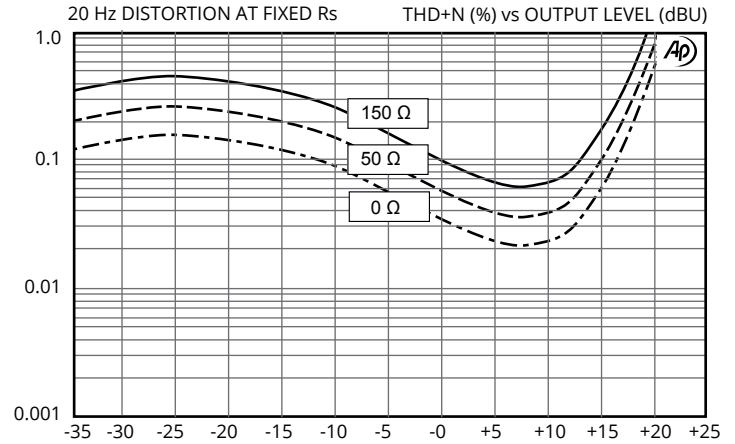
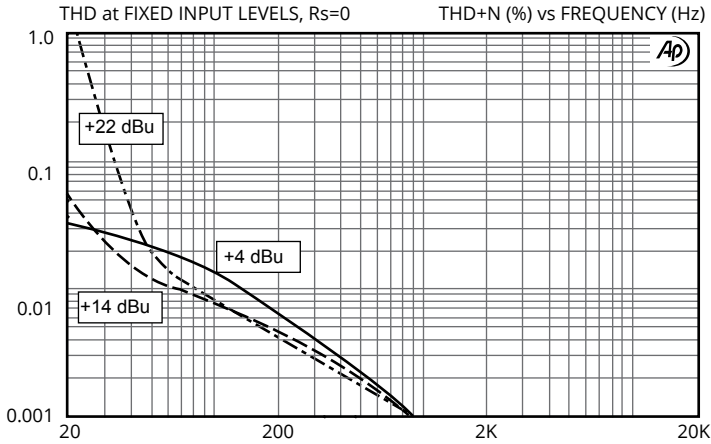

PARAMETER	CONDITIONS	MINIMUM	TYPICAL	MAXIMUM
Input impedance, Zi	20 Hz to 20 kHz, 0 dBu, test circuit 3	705 Ω	716 Ω	725 Ω
Voltage gain	1 kHz, 0 dBu, test circuit 1, Rs = 0 Ω	-1.8 dB	-1.6 dB	-1.4 dB
Magnitude response, ref 1 kHz	20 Hz, 0 dBu, test circuit 1, Rs = 0 Ω	-0.10 dB	-0.03 dB	±0.0 dB
	20 kHz, 0 dBu, test circuit 1, Rs = 0 Ω	-0.10 dB	±0.00 dB	+0.10 dB
Deviation from linear phase (DLP)	20 Hz to 20 kHz, 0 dBu, test circuit 1, Rs = 0 Ω		+0.3/-0°	±1.0°
Bandwidth	LF -3 dB re 1 kHz, test circuit 1, Rs = 0 Ω		0.20 Hz	
	HF -3 dB re 1 kHz, test circuit 1, Rs = 0 Ω		15 MHz	
Distortion (THD)	1 kHz, +4 dBu, test circuit 1, Rs = 0 Ω		<0.001%	
	20 Hz, +4 dBu, test circuit 1, Rs = 0 Ω		0.035%	0.15%
Maximum output level	20 Hz, 1% THD, test circuit 1, Rs = 0 Ω	+19 dBu	+21 dBu	
Common-mode rejection ratio(CMRR)	60 Hz, test circuit 2		94 dB	
	3 kHz, test circuit 2	75 dB	83 dB	
Output impedance, Zo	20 Hz to 20 kHz, 0 dBu, test circuit 4		116 Ω	
Optimal cable length	input		50 m (165')	200 m (650')
	output		No limitations	
Temperature range	operation or storage	0°C		70°C
Breakdown voltages 60 Hz, 1 minute test duration*	winding to winding	250 V RMS		
	winding to frame	500 V RMS		

All levels are output unless noted

Test Circuit 1:

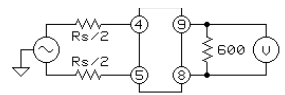

Test Circuit 2:

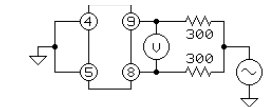

Test Circuit 3:

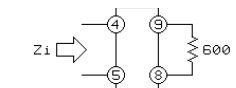

Test Circuit 4:

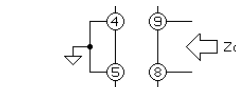

All minimum and maximum specifications are guaranteed. Unless noted otherwise, all specifications apply at 25°C. Specifications subject to change without notice. All information herein is believed to be accurate and reliable, however no responsibility is assumed for its use nor for any infringements of patents which may result from its use. No license is granted by implication or otherwise under any patent or patent rights of Jensen Transformers, Inc.

* IMPORTANT NOTE: THIS PRODUCT IS NOT INTENDED FOR USE IN CIRCUMSTANCES WHERE THE DC OR PEAK AC VOLTAGE BETWEEN INPUT AND OUTPUT CONNECTIONS EXCEEDS 34 VOLTS OR WHERE ITS FAILURE COULD CAUSE INJURY OR DEATH.