

LINE OUTPUT TRANSFORMER QUADFILAR WINDINGS

- Distortion 0.018% typ at 20 Hz and +4 dBu output level
- Wide bandwidth: -3 dB at 0.1 Hz and 180 kHz
- Drives 600 Ω loads to levels up to +24 dBu at 20 Hz
- Excellent time domain performance: DLP 0.6° typ 20 Hz to 20 kHz
- Insertion loss only 1.1 dB when driving 600 Ω load

This transformer is designed for high performance line output stages. Its 50% nickel core alloy gives it excellent level handling and low distortion for its size.

Its separate windings allow connection for step-up or step-down applications. Driving signals should be free of DC and source impedance as low as possible.

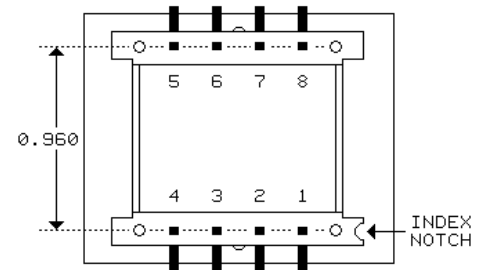
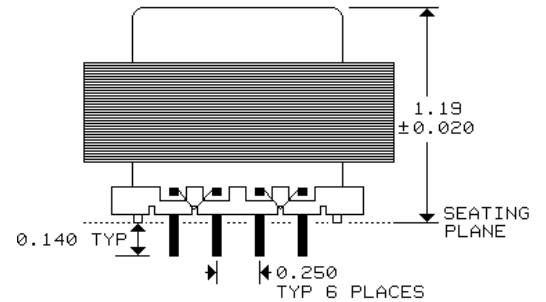
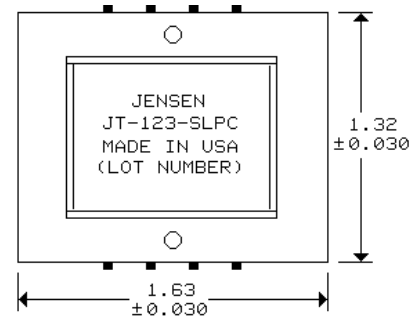
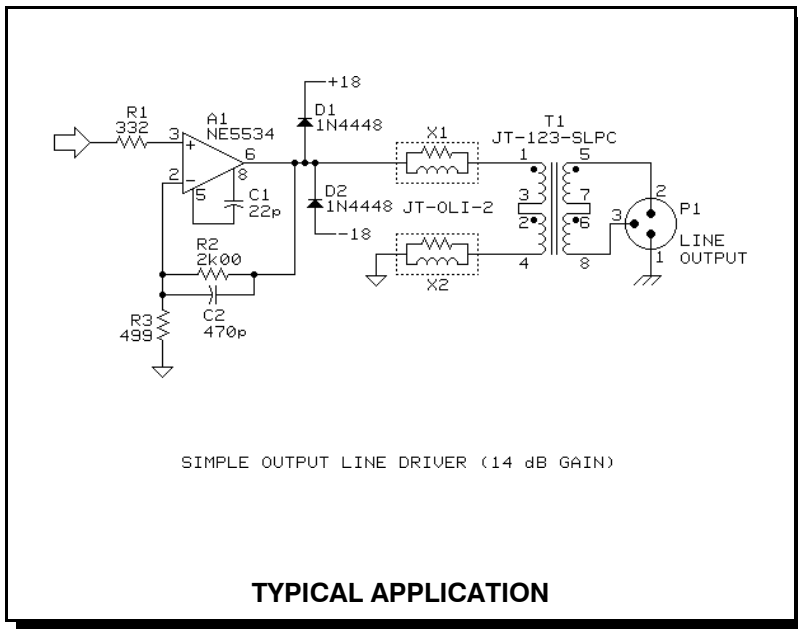

PIN NUMBERS NOT MARKED ON PART
PINS ARE 0.025 SQUARE, 8 PLACES
0.040 DIA PC HOLES RECOMMENDED

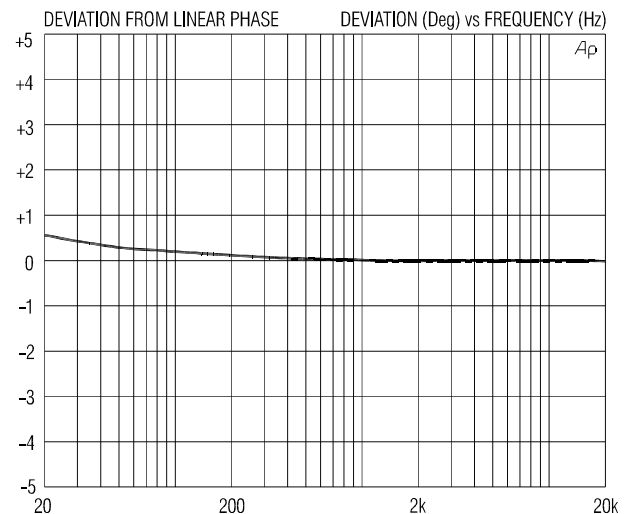
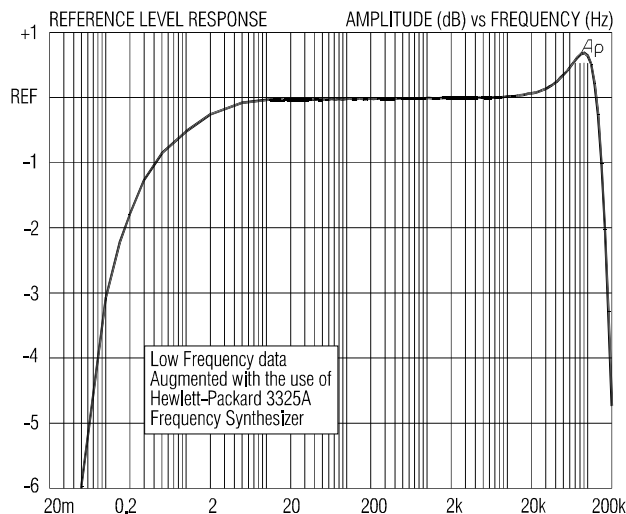

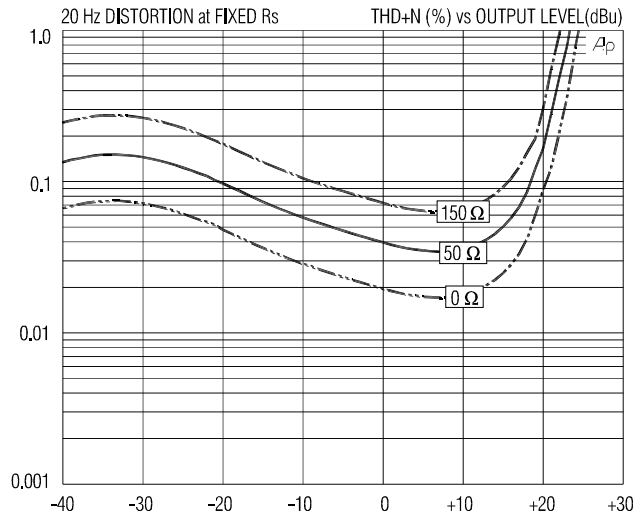
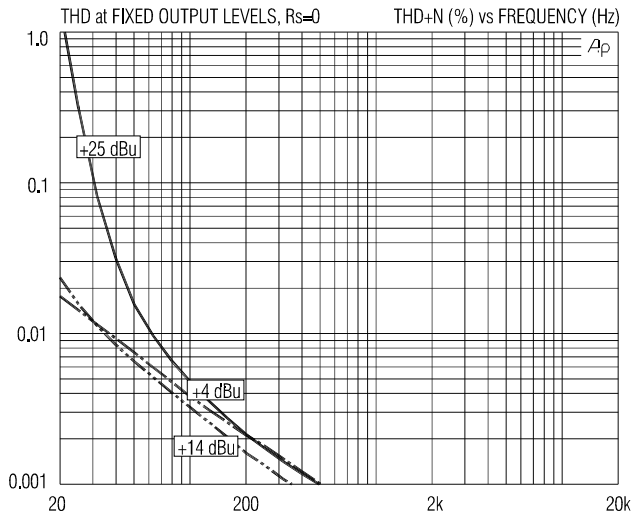

JT-123-SLPC SPECIFICATIONS (1:1 series/series configuration, all levels are output unless noted)

PARAMETER	CONDITIONS	MINIMUM	TYPICAL	MAXIMUM
Input impedance, Zi	20 Hz to 20 kHz, 0 dBu, test circuit 3	670 Ω	680 Ω	695 Ω
Voltage gain	1 kHz, 0 dBu, test circuit 1, Rs=0 Ω	-1.3 dB	-1.1 dB	-0.9 dB
Magnitude response, ref 1 kHz	20 Hz, 0 dBu, test circuit 1, Rs=0 Ω	-0.10 dB	-0.04 dB	±0.0 dB
	20 kHz, 0 dBu, test circuit 1, Rs=0 Ω	±0.0 dB	+0.04 dB	+0.15 dB
Deviation from linear phase (DLP)	20 Hz to 20 kHz, 0 dBu, test circuit 1, Rs=0 Ω		+0.6/-0°	±1.0°
Bandwidth	LF -3 dB re 1 kHz, test circuit 1, Rs=0 Ω		0.10 Hz	
	HF -3 dB re 1 kHz, test circuit 1, Rs=0 Ω		180 kHz	
Distortion (THD)	1 kHz, +4 dBu, test circuit 1, Rs=0 Ω		<0.001%	
	20 Hz, +4 dBu, test circuit 1, Rs=0 Ω		0.018%	0.1%
Maximum output level	20 Hz, 1% THD, test circuit 1, Rs=0 Ω	+23 dBu	+24 dBu	
Common-mode rejection ratio (CMRR)	60 Hz, test circuit 2		85 dB	
	3 kHz, test circuit 2	40 dB	50 dB	
Output impedance, Zo	20 Hz to 20 kHz, 0 dBu, test circuit 4		80 Ω	
DC resistance	each winding		20 Ω	
Capacitance	both primaries to both secondaries, 1 kHz		16 nF	
	all windings to frame, 1 kHz		48 pF	
Turns ratio		0.999:1	1.000:1	1.001:1
Temperature range	operation or storage	0° C		70° C
Breakdown voltages 60 Hz, 1 minute test duration (see IMPORTANT NOTE below)	winding to winding	250 V RMS		
	winding to frame	500 V RMS		

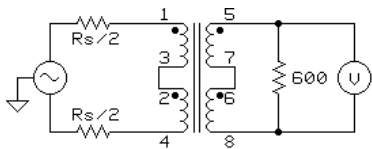

TEST CIRCUIT 1

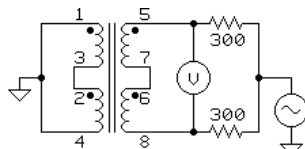

TEST CIRCUIT 2

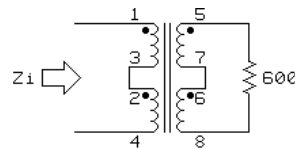

TEST CIRCUIT 3

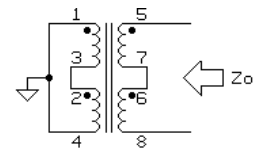

TEST CIRCUIT 4

All minimum and maximum specifications are guaranteed. Unless noted otherwise, all specifications apply at 25°C. Specifications subject to change without notice. All information herein is believed to be accurate and reliable, however no responsibility is assumed for its use nor for any infringements of patents which may result from its use. No license is granted by implication or otherwise under any patent or patent rights of Jensen Transformers, Inc.

IMPORTANT NOTE: This device is NOT intended for use in life support systems or any application where its failure could cause injury or death. The breakdown voltage specification is intended to insure integrity of internal insulation systems; continuous operation at these voltages is NOT recommended. Consult our applications engineering department if you have special requirements.

JENSEN TRANSFORMERS, INC., 7135 Hayvenhurst Avenue, Van Nuys, CA 91406-3807, USA
(818) 374-5857 • FAX (818) 374-5856 • www.jensen-transformers.com